

High-efficiency Circulator Pump

Installation/Operating Manual
Magna D Smedegaard



Legal information/Copyright

Original operating manual Magneta D Smedegaard

All rights reserved. The contents provided herein must neither be distributed, copied, reproduced, edited or processed for any other purpose, nor otherwise transmitted, published or made available to a third party without the manufacturer's express written consent.

Subject to technical modification without prior notice.

© Duijvelaar Pompen, Alphen aan den Rijn, Nederland 21/01/2016

Contents

	Glossary	5
1	General.....	6
	1.1 Principles	6
	1.2 Target group	6
	1.3 Symbols.....	6
2	Safety	7
	2.1 Key to safety symbols/markings	7
	2.2 General.....	7
	2.3 Intended use.....	7
	2.4 Personnel qualification and training.....	8
	2.5 Consequences and risks caused by non-compliance with this manual.....	8
	2.6 Safety awareness	8
	2.7 Safety information for the operator/user	9
	2.8 Safety information for maintenance, inspection and installation.....	9
	2.9 Unauthorised modes of operation.....	9
3	Transport/Temporary Storage/Disposal	10
	3.1 Checking the condition upon delivery	10
	3.2 Transport	10
	3.3 Storage/preservation	10
	3.4 Return to supplier	11
	3.5 Disposal.....	11
4	Description of the Pump (Set)	12
	4.1 General description.....	12
	4.2 Designation.....	12
	4.3 Name plate	13
	4.4 Design details	13
	4.5 Configuration and function.....	15
	4.6 Noise characteristics.....	15
	4.7 Scope of supply	15
	4.8 Dimensions and weight.....	16
	4.9 Technical data	17
5	Installation at Site	18
	5.1 Safety regulations	18
	5.2 Checks to be carried out prior to installation.....	18
	5.3 Installing the pump set.....	18
	5.4 Connecting the piping	20
	5.5 Enclosure/insulation.....	20
	5.6 Electrical connection.....	21
	5.6.1 Routing the cables	24
	5.6.2 Terminating resistors in a Modbus system.....	26
6	Commissioning/Start-up/Shutdown	27
	6.1 Commissioning/start-up.....	27
	6.1.1 Prerequisites for commissioning/start-up	27
	6.1.2 Priming and venting the pump	27



6.1.3	Start-up	27
6.1.4	Operation	28
6.1.5	Operating mode	30
6.2	Shutdown	48
6.3	Operating limits	48
6.3.1	Ambient temperature	48
6.3.2	Density of the fluid handled	49
6.4	Shutdown/storage/preservation	49
6.4.1	Measures to be taken for shutdown	49
6.5	Returning to service	49
7	Servicing/Maintenance	50
7.1	Servicing/inspection	50
7.2	Drainage/cleaning	50
7.3	Removing the pump set from the piping	50
7.3.1	Dismantling the complete pump set	50
8	Trouble-shooting.....	52
9	Related Documents	54
9.1	Sectional drawing with list of components	54
9.2	Wiring diagrams	55
9.2.1	Wiring of dual pumps	56
10	EC Declaration of Conformity.....	59
	Index.....	60

Glossary

Discharge line

The pipeline which is connected to the discharge nozzle

Noise characteristics

The noise emission to be expected, indicated as sound pressure level LpA in dB(A)

Pump

Machine without drive, additional components or accessories

Pump set

Complete pump set consisting of pump, drive, additional components and accessories

Suction lift line/suction head line

The pipeline which is connected to the suction nozzle

1 General

1.1 Principles

This operating manual is supplied as an integral part of the type series and variants indicated on the front cover. The manual describes the proper and safe use of this equipment in all phases of operation.

The name plate indicates the type series/size and main operating data. They uniquely identify the pump (set) and serve as identification for all further business processes.

In the event of damage, immediately contact your nearest DP service centre to maintain the right to claim under warranty.

Noise characteristics see [⇒ Section 4.6, Page 15]

1.2 Target group

This operating manual is aimed at the target group of trained and qualified specialist technical personnel.

1.3 Symbols

Table 1: Symbols used in this manual

Symbol	Description
✓	Conditions which need to be fulfilled before proceeding with the step-by-step instructions
▷	Safety instructions
⇒	Result of an action
⇔	Cross-references
1. 2.	Step-by-step instructions
	Note Recommendations and important information on how to handle the product







2 Safety



All the information contained in this section refers to hazardous situations.

2.1 Key to safety symbols/markings

Table 2: Definition of safety symbols/markings

Symbol	Description
 DANGER	DANGER This signal word indicates a high-risk hazard which, if not avoided, will result in death or serious injury.
 WARNING	WARNING This signal word indicates a medium-risk hazard which, if not avoided, could result in death or serious injury.
 CAUTION	CAUTION This signal word indicates a hazard which, if not avoided, could result in damage to the machine and its functions.
	General hazard In conjunction with one of the signal words this symbol indicates a hazard which will or could result in death or serious injury.
	Electrical hazard In conjunction with one of the signal words this symbol indicates a hazard involving electrical voltage and identifies information about protection against electrical voltage.
	Machine damage In conjunction with the signal word CAUTION this symbol indicates a hazard for the machine and its functions.

2.2 General

This manual contains general installation, operating and maintenance instructions that must be observed to ensure safe pump operation and prevent personal injury and damage to property.

The safety information in all sections of this manual must be complied with.

This manual must be read and completely understood by the specialist personnel/operators responsible prior to installation and commissioning.

The contents of this manual must be available to the specialist personnel at the site at all times.

Information attached directly to the pump must always be complied with and be kept in a perfectly legible condition at all times. This applies to, for example:

- Arrow indicating the direction of rotation
- Markings for connections
- Name plate

The operator is responsible for ensuring compliance with all local regulations not taken into account in this manual.

2.3 Intended use

- The pump (set) must only be operated within the operating limits described in the other applicable documents.
- Only operate pumps/pump sets which are in perfect technical condition.
- Do not operate the pump (set) in partially assembled condition.

- Only use the pump to handle the fluids described in the data sheet or product literature of the pump model or variant.
- Never operate the pump without the fluid to be handled.
- Observe the minimum flow rates indicated in the data sheet or product literature (to prevent overheating, bearing damage, etc).
- Observe the maximum flow rates indicated in the data sheet or product literature (to prevent overheating, mechanical seal damage, cavitation damage, bearing damage, etc).
- Do not throttle the flow rate on the suction side of the pump (to prevent cavitation damage).
- Consult the manufacturer about any use or mode of operation not described in the data sheet or product literature.

Prevention of foreseeable misuse

- Never exceed the permissible operating limits specified in the data sheet or product literature regarding pressure, temperature, etc.
- Observe all safety information and instructions in this manual.

2.4 Personnel qualification and training

All personnel involved must be fully qualified to transport, install, operate, maintain and inspect the equipment this manual refers to.

The responsibilities, competence and supervision of all personnel involved in transport, installation, operation, maintenance and inspection must be clearly defined by the operator.

Deficits in knowledge must be rectified by means of training and instruction provided by sufficiently trained specialist personnel. If required, the operator can commission the manufacturer/supplier to train the personnel.

Training on the pump (set) must always be supervised by technical specialist personnel.

This device may be operated by **children** from the age of 8 as well as by persons of limited physical, sensory or mental abilities or lacking experience and knowledge, provided that they are supervised, they have been instructed on how to use this device safely and they understand the hazards it presents. It is impermissible for **children** to play with this device. **Children** must not clean the device or perform any **service work to be carried out by the operator** at the device without supervision.

2.5 Consequences and risks caused by non-compliance with this manual

- Non-compliance with this operating manual will lead to forfeiture of warranty cover and of any and all rights to claims for damages.
- Non-compliance can, for example, have the following consequences:
 - Hazards to persons due to electrical, thermal, mechanical and chemical effects and explosions
 - Failure of important product functions
 - Failure of prescribed maintenance and servicing practices
 - Hazard to the environment due to leakage of hazardous substances

2.6 Safety awareness

In addition to the safety information contained in this manual and the intended use, the following safety regulations shall be complied with:

- Accident prevention, health and safety regulations
- Explosion protection regulations

- Safety regulations for handling hazardous substances
- Applicable standards, directives and laws

2.7 Safety information for the operator/user

- The operator shall fit contact guards for hot, cold and moving parts and check that the guards function properly.
- Do not remove any contact guards during operation.
- Contain leakages (e.g. at the shaft seal) of hazardous fluids handled (e.g. explosive, toxic, hot) so as to avoid any danger to persons and the environment. Adhere to all relevant laws.
- Eliminate all electrical hazards. (In this respect refer to the applicable national safety regulations and/or regulations issued by the local energy supply companies.)
- If shutting down the pump does not increase potential risk, fit an emergency-stop control device in the immediate vicinity of the pump (set) during pump set installation.

2.8 Safety information for maintenance, inspection and installation

- Modifications or alterations of the pump are only permitted with the manufacturer's prior consent.
- Use only original spare parts or parts authorised by the manufacturer. The use of other parts can invalidate any liability of the manufacturer for resulting damage.
- The operator ensures that maintenance, inspection and installation is performed by authorised, qualified specialist personnel who are thoroughly familiar with the manual.
- Only carry out work on the pump (set) during standstill of the pump.
- The pump casing must have cooled down to ambient temperature.
- Pump pressure must have been released and the pump must have been drained.
- When taking the pump set out of service always adhere to the procedure described in the manual. [⇒ Section 6.4, Page 49]
- Decontaminate pumps which handle fluids posing a health hazard.
- As soon as the work has been completed, re-install and/or re-activate any safety-relevant and protective devices. Before returning the product to service, observe all instructions on commissioning. [⇒ Section 6.1, Page 27]

2.9 Unauthorised modes of operation

Never operate the pump (set) outside the limits stated in the data sheet and in this manual.

The warranty relating to the operating reliability and safety of the supplied pump (set) is only valid if the equipment is used in accordance with its intended use.

3 Transport/Temporary Storage/Disposal

3.1 Checking the condition upon delivery

1. On transfer of goods, check each packaging unit for damage.
2. In the event of in-transit damage, assess the exact damage, document it and notify DP or the supplying dealer (as applicable) and the insurer about the damage in writing immediately.

3.2 Transport



⚠ DANGER
The pump (set) could slip out of the suspension arrangement
Danger to life from falling parts!

- Always transport the pump (set) in the specified position.
- Pay attention to the weight data and the centre of gravity.
- Observe the applicable local health and safety regulations.
- Use suitable, permitted lifting accessories, e.g. self-tightening lifting tongs.

To transport the pump/pump set suspend it from the lifting tackle as shown.



Fig. 1: Proper pump transport



Fig. 2: Incorrect pump transport

3.3 Storage/preservation

If commissioning is to take place some time after delivery, we recommend that the following measures be taken for pump (set) storage.



CAUTION
Damage during storage by humidity, dirt, or vermin
Corrosion/contamination of the pump (set)!

- For outdoor storage cover the packed or unpacked pump (set) and accessories with waterproof material.



CAUTION

Wet, contaminated or damaged openings and connections

Leakage or damage to the pump!

- Clean and cover pump openings and connections as required prior to putting the pump into storage.

Store the pump (set) in a dry, protected room where the atmospheric humidity is as constant as possible.

If properly stored indoors, the pump set is protected for a maximum of 12 months.

For storing a pump (set) which has already been operated, observe the instructions in [⇒ Section 6.4.1, Page 49]

3.4 Return to supplier

1. Drain the pump as per operating instructions. [⇒ Section 7.2, Page 50]
2. Always flush and clean the pump, particularly if it has been used for handling noxious, explosive, hot or other hazardous fluids.
3. If the pump set has handled fluids whose residues could lead to corrosion in the presence of atmospheric humidity or could ignite upon contact with oxygen, the pump set must also be neutralised, and anhydrous inert gas must be blown through the pump to ensure drying.
4. Always complete and enclose a certificate of decontamination when returning the pump (set).
Always indicate any safety and decontamination measures taken.

3.5 Disposal



WARNING

Fluids, consumables and supplies which are hot and/or pose a health hazard

Hazard to persons and the environment!

- Collect and properly dispose of flushing fluid and any residues of the fluid handled.
- Wear safety clothing and a protective mask, if required.
- Observe all legal regulations on the disposal of fluids posing a health hazard.

1. Dismantle the pump (set).
Collect greases and other lubricants during dismantling.
2. Separate and sort the pump materials, e.g. by:
 - Metals
 - Plastics
 - Electronic waste
 - Greases and other lubricants
3. Dispose of materials in accordance with local regulations or in another controlled manner.

4 Description of the Pump (Set)

4.1 General description

Glandless, non-self-priming in-line pumps for handling clean or aggressive fluids which are neither chemically nor mechanically aggressive to the pump materials. The combination of a high-efficiency hydraulic system with high-efficiency motor technology, integrated differential pressure control and operating software enables an optimum adjustment of the glandless pumps to changing operating conditions and minimises operating costs.



Fig. 3: Magneta D Smedegaard description

1	Motor with control module	2	Connections for data cables
3	Display	4	Control element (press & turn)
5	Connections for power supply and general fault message		

The motor with control module (2) is fastened to the pump casing (1) with four screws. The control module adjusts the differential pressure of the pump to a setpoint which can be set within the control range. The criteria for differential pressure control depend on the set operating mode. In all operating modes, the pump adapts to fluctuating demand (e.g. from control valves being activated).

Advantages of a pump-integrated control system are savings in energy and operating costs and a reduction in flow noises as unnecessarily high heads are reduced. In addition, the combination of an efficient hydraulic system with a high-efficiency electric motor makes sure that the input power is converted into hydraulic energy as efficiently as possible at all times. The newly developed Eco Mode enables further savings in energy and operating costs.

4.2 Designation

Example: Magneta D Smedegaard 30-100

Table 3: Designation key

Code	Description
Magneta D Smedegaard	Type series
30	Nominal diameter of pipe connection
	30 R 1 1/4
	32 to 65 DN 32 to DN 65
100	Head in m x 10 (example 100 = 10 m)

4.3 Name plate

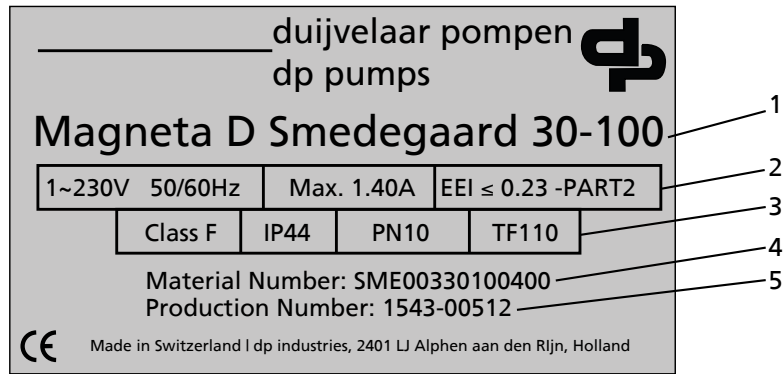

Fig. 4: Name plate (example)

1	Type series, size	2	Voltage, frequency, max. input power, energy efficiency index (EEI)
3	Thermal class, enclosure, pressure class, temperature class	4	Material number
5	Production number		

Key to the production number

Example: 1543-000512

Table 4: Key to the production number

Code	Description
15	Year of production 2015
43	Week of production (week 43)
000512	Consecutive number

4.4 Design details

Design

- Highly efficient, maintenance-free wet rotor pump (glandless)
- Twin pump

Drive

- High-efficiency electric motor with continuously variable differential pressure control
- Electronically commutated synchronous motor with permanent magnet rotor
- Integrated motor protection
- 1~230 VAC, 50/60 Hz
- IP44 enclosure
- Thermal class F
- Temperature class TF 110
- Interference emissions EN 61 000-6-3
- Interference immunity EN 61 000-6-2

Bearings

- Product-lubricated special plain bearing

Connections

- Screw-ended or flanged

Operating modes

- Constant-pressure and proportional-pressure control
- Eco Mode with dynamic differential pressure setpoint adjustment
- Boost Mode with manual setpoint input

Automatic functions

- Continuous output adjustment depending on the operating mode
- 0 – 10 V with external differential pressure/speed setpoint
- Dual-pump operation
- Pump changeover after 24 hours runtime of a pump
- Redundancy by automatic start-up of the stand-by pump in the event of a duty pump failure
- Modbus
- Setback operation
- External start/stop
- Deblocking function
- Self-venting function
- Soft start

Manual functions

- Setting the operating mode
- Setting the differential pressure setpoint
- Setting the speed level
- Locking the control panel

Signalling and display functions

- General fault message
- Error codes indicated on the display

Additional for pumps 40-120/-180, 50-100/-120, 65-80/-120

- Integrated "in operation" message (volt-free changeover contact)
- Alternating display of flow rate, electrical input power, and head

Pumps 30-60/-100, 32-80/-120, 40-80/-100, 50-80

- Alternating display of flow rate and electrical input power

4.5 Configuration and function

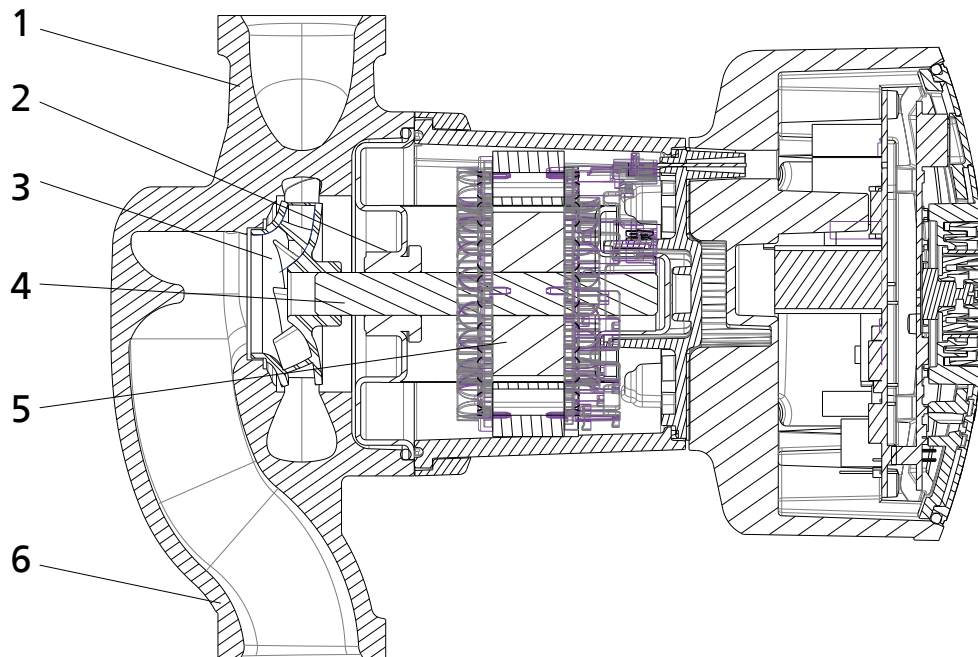

Fig. 5: Sectional drawing of the pump

1	Discharge nozzle	2	Radial plain bearing
3	Impeller	4	Motor shaft
5	Motor	6	Suction nozzle

Design The pump is designed with a radial fluid inlet and a radial outlet arranged on the same axis. The impeller is rigidly connected to the motor shaft. Mechanical sealing is not required as the rotating assembly is completely isolated from the stator winding. The rotating assembly is lubricated and cooled by the fluid handled. The motor housing is made of aluminium. Most of the internal parts are made of stainless steel. The advanced lubricating system, high-quality graphite bearings and precision-balanced impeller ensure smooth running and a long service life.

Function The fluid enters the pump via the suction nozzle (6) and is accelerated outward in a cylindrical flow by the rotating impeller (3), which is driven by the motor shaft (4). In the flow passage of the pump casing the kinetic energy of the fluid is converted into pressure energy. The fluid is pumped to the discharge nozzle (1), where it leaves the pump. The shaft runs in radial plain bearings (2), which are supported by the motor (5).

4.6 Noise characteristics

Table 5: Noise characteristics [dB A]

	Sound pressure level
All	45 max.

15 / 64

4.7 Scope of supply

Depending on the model, the following items are included in the scope of supply:

- Pump set
- Two sealing elements
- Installation/operating manual

Accessories

- BACnet MS/TP communication module (cabinet-mounted) for connecting one pump
- BACnet IP communication module (cabinet-mounted) with 100 data points for connecting several pumps
- Communication module (wall-mounted) for connecting up to 6 pumps, for signalling an "in operation" or alarm message (general fault message)
- Communication module (wall-mounted) for connecting one pump, for signalling an "in operation" or alarm message (general fault message)
- Communication module (cabinet-mounted) for connecting one pump, for signalling an "in operation" or alarm message (general fault message)
- Pipe unions
- Flange spacers

4.8 Dimensions and weight

For dimensions and weights please refer to the type series booklet of the pump.

4.9 Technical data

Table 6: Technical data

Characteristic	Value
Maximum flow rate	Depends on the pump type, see type series booklet
Maximum head	Depends on the pump type, see type series booklet
Speed	Depends on the pump type, see type series booklet
Mains voltage	1~ 230 VAC +/- 10 %
Frequency	50 Hz / 60 Hz
Nominal current	See name plate
Thermal class	F
Enclosure	IP44
Input power P1	Depends on the pump type, see type series booklet
Nominal diameter	See name plate / type code in the type series booklet
Mating flanges	See name plate / type code in the type series booklet
Pump weight	Depends on the pump type, see type series booklet
Permissible ambient temperature	0 °C to +40 °C
Maximum relative humidity	≤ 80 %
Permissible fluid temperature	-10 °C to + 110 °C
Maximum permissible operating pressure	PN 10 ¹⁾ / PN 16 ²⁾
Sound pressure level	< 45 dB (A)
Minimum inlet pressure	80 °C: 0.5 bar; 95 °C: 1.5 bar
Permissible fluids	Heating water to VDI 2035 Water/glycol mixture, max. mixing ratio 1:1 ³⁾ (only use brand name products with corrosion inhibitors; observe the information provided by the producer as well as the safety data sheets). Fluids other than those above must only be used upon prior approval by the pump manufacturer. For ethylene/propylene glycols with corrosion inhibitors, commercial oxygen binders, anti-corrosives, fluids with several additives, and cooling brines see the following danger note.
EEL	See type series booklet. ⁴⁾
EMC (electromagnetic compatibility)	2004/108/EC
Interference emissions	EN 61000-6-3
Interference immunity	EN 61000-6-2



⚠ DANGER

Non-compliance with manufacturer's instructions

Personal injury and damage to property!

- Use permissible fluids only.
- Always observe the safety data sheets and manufacturer's instructions!
- Observe the manufacturer's instructions on mixing ratios.
- If any additives are to be mixed into the fluid, do so on the discharge side of the pump.

¹⁾ Standard design

²⁾ Special design (surcharge applies)

³⁾ If any glycol is contained in the fluid, the operating data of the pump must be adjusted to a higher viscosity, depending on the mixing ratio.

⁴⁾ Reference value for the most efficient of circulators: EEI ≤ 0.20

5 Installation at Site

5.1 Safety regulations

	<p>⚠ DANGER Installation in potentially explosive atmospheres Explosion hazard!</p> <ul style="list-style-type: none">➤ Never install the pump in potentially explosive atmospheres.➤ Observe the information given in the data sheet and on the name plates of the pump system.
---	---

	<p>⚠ DANGER Use for drinking water or foodstuff applications Danger of poisoning!</p> <ul style="list-style-type: none">➤ The pump materials are not suitable for drinking water and foodstuff applications. Never use the pump for drinking water or foodstuff applications.
---	---

5.2 Checks to be carried out prior to installation

Before installing the pump make sure that the following requirements are met:

- Check the data on the name plate of the pump to make sure it can be operated on the available mains.
- The fluid to be handled matches the description of suitable fluids.
- The above safety instructions have been complied with.

5.3 Installing the pump set

Install the pump set in an easily accessible place. An arrow on the pump casing and thermal insulation shell indicates the direction of flow.

	<p>CAUTION Ingress of fluid into the motor Damage to the pump set!</p> <ul style="list-style-type: none">➤ Install the pump set with the pump shaft in horizontal position. Connect the piping without transmitting any stresses and strains.➤ Never install the pump set with the motor terminal box pointing downwards.➤ Undo the hexagon socket head cap screws. Then turn the motor housing.
---	--

	<p>NOTE Installing shut-off valves upstream and downstream of the pump is recommended. Make sure that no leaking water can drip into the pump motor or terminal box.</p>
---	--

**DANGER****Leakage at the pump**

Leakage of hot fluids!

- Fit the sealing elements and make sure they are positioned correctly.

An arrow on the pump casing indicates the direction of flow.

**NOTE**

The direction of flow of a vertically installed pump should be upwards.

**CAUTION****Air entering the pump**

Damage to vertically installed pump sets whose direction of flow is downwards!

- Fit a vent valve at the highest point of the suction line.

**NOTE**

Do not install the pump at the lowest point of the system to prevent any impurities from collecting in the pump.

Table 7: Permissible installation positions

Sizes	
All	

Adjusting the display panel

The drive unit with integrated display can be rotated.

1. Loosen the four hexagon socket head cap screws.
2. Rotate the drive unit until it has reached the required position.
3. Re-tighten the four hexagon socket head cap screws.

**DANGER****Leakage at the pump**

Leakage of hot fluids!

- Insert the O-ring in the correct position.

Screw-ended pumps

1. Place the pump in the specified installation position.
2. Accurately insert the sealing element.
3. Establish a screwed connection between pump and piping.
4. Tighten the screwed connection hand-tight with an assembly tool (e.g. pipe wrench).
5. Accurately insert the sealing element in the opposite part on the screwed connection.
6. Tighten the screwed connection hand-tight with an assembly tool (e.g. pipe wrench).

Flanged pump

1. Place the pump in the specified installation position.
2. Accurately insert the sealing element.
3. Connect the pump flange to the pipe flange by means of screws.

4. Tighten the screws hand-tight with an assembly tool (e.g. wrench).
5. Accurately insert the sealing element on the opposite side.
6. Connect the pump flange to the pipe flange by means of screws. Tighten the screws hand-tight.

5.4 Connecting the piping



⚠ DANGER

Excessive loads acting on the pump nozzles

Danger to life from leakage of hot fluids!

- Do not use the pump as an anchorage point for the piping.
- Anchor the pipelines in close proximity to the pump and connect them without transmitting any stresses or strains.
- Take appropriate measures to compensate thermal expansion of the piping.



CAUTION

Contamination/dirt in the piping

Damage to the pump!

- Flush the piping prior to commissioning or replacing the pump. Remove any foreign matter.



NOTE

Installing check and shut-off elements in the system is recommended, depending on the type of plant and pump. However, such elements must not obstruct proper drainage or hinder disassembly of the pump.

- ✓ Suction lift lines have been laid with a rising slope, suction head lines with a downward slope towards the pump.
 - ✓ The nominal diameters of the pipes are equal to or greater than the nominal diameters of the pump nozzles.
 - ✓ The pipelines have been anchored in close proximity to the pump and connected without transmitting any stresses or strains.
1. Thoroughly clean, flush and blow through all vessels, pipelines and connections (especially of new installations).



CAUTION

Welding beads, scale and other impurities in the piping

Damage to the pump!

- Free the piping from any impurities.

5.5 Enclosure/insulation



⚠ WARNING

The pump takes on same temperature as the fluid handled

Risk of burns!

- Insulate the volute casing.
- Fit protective equipment.

5.6 Electrical connection



⚠ DANGER

Electrical connection work by unqualified personnel

Danger of death from electric shock!

- Always have the electrical connections installed by a trained and qualified electrician.
- Observe regulations IEC 60364.



⚠ DANGER

Work performed on an energised terminal box

Danger of death from electric shock!

- Switch off the supply voltage at least 5 minutes prior to commencing work and ensure that it cannot be switched on again unintentionally.



⚠ DANGER

Pump acting as a generator when running in reverse

Danger to life from hazardous induction voltage at the motor terminals!

- Prevent the fluid from flowing back by closing the shut-off elements.



⚠ WARNING

Incorrect connection to the mains

Damage to the mains network, short circuit!

- Observe the technical specifications of the local energy supply companies.



NOTE

The cable must be of type H05VV-F 3G1 or similar, with an outside diameter ≥ 7.2 mm. Circuit breaker: 10/16 A (minimal rated current x 1.4) slow blowing fuse or automatic circuit breaker type C.



NOTE

Connection to the power supply must be effected by means of a fixed power cable with a minimum cross-section of 3×1.5 mm², which is fitted with a plug-type connection or an all-pole isolating switch with a minimum contact opening of 3 mm.



NOTE

Connection to the power supply must be effected by a power cable which is fitted with an all-pole isolating switch or a plug-type connection.

Should the power cable of this device become damaged, a replacement cable must be fitted by the manufacturer, the manufacturer' customer service technicians or a similarly qualified person to prevent any hazards.

The cables for the power supply and for transmitting a general fault message as well as the data cables are wired to plug-in terminals located on both sides of the pump. The terminals are arranged in 2 terminal wiring compartments with a screwed-on cover each (IP 44). On one side of the housing, the cables for the power supply and general fault message are guided and wired to the pump. The corresponding symbols for the connections are marked on the cover.

The terminal wiring compartment for data signals (Modbus, 0 - 10 VDC, External Start/Stop, Dual-pump Operation) is located on the opposite side of the housing and marked by the corresponding symbols on the cover.



Fig. 6: Front left view of a Magneta D Smedegaard pump

A1	Symbol for connection required for Dual-pump Operation (DUAL)
B1	Symbol for connection to Modbus network
C1	Symbol for connection of External Start/Stop signal
D1	Symbol for connection of external analog 0 - 10 VDC signal

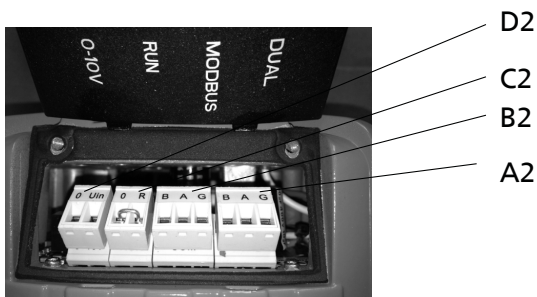

Fig. 7: Terminal wiring compartment for the data cables

D2	Terminal pair for the external analog 0 - 10 VDC signal connection
C2	Terminal pair for the External Start/Stop signal connection
B2	Terminal pair for connection to Modbus network
A2	Terminal pair for connection required for Dual-pump Operation



Fig. 8: Front right view of a Magneta D Smedegaard pump

E1	Symbol for connection of volt-free general fault message
F1	Symbol for connection of power supply 1~230 VAC, 50/60 Hz
G1	Symbol for "in operation" message relay (not shown in the illustration, for pump sizes 40-120/-180, 50-100/-120 and 65-80/-120)



NOTE

If the unit is to be switched off by means of a mains relay, this relay has to meet the following requirements as a minimum: rated current ≥ 10 A, rated voltage 250 VAC.

Table 8: Key to the symbols

Function	Symbol	Terminal pair	Terminal cross-section	Terminal identification	Frequency of starts	Contact rating
Power supply 1~230 VAC, 50/60 Hz		1 2 3 	1.5 mm ²	3 - PE 2 - N 1 - L	< 20 / 24 h	
General fault message		1 2 3 	1.5 mm ²	3 - NO 2 - COM 1 - NC		Min: 12 VDC at 10 mA Max: 250 V at 1 A
External analog 0 - 10 VDC signal	0 - 10 V	1 2 	1.5 mm ²	1 - 0 2 - Uin		
External signal for start/stop of pump (terminal pair supplied bridged)	RUN	1 2 	1.5 mm ²	1 - 0 2 - R		
ModBus [®]	Modbus	1 2 3 	1.5 mm ²	3 - G 2 - A 1 - B		
Dual-pump operation	DUAL	1 2 3 	1.5 mm ²	3 - G 2 - A 1 - B		
"In operation" message [®]		1 2 3 	1.5 mm ²	3 - NO 2 - COM 1 - NC		Min: 12 VDC at 10 mA Max: 250 V at 1 A

Connecting the cables at the pump

1. Verify the supply voltage at the site against the data on the name plate of the pump.
2. Undo the two screws at the cover of the terminal wiring compartment. Take this cover off the drive unit.
3. Wire the cables to the terminals as indicated in the wiring diagram.

4. Fit the cover on the terminal wiring compartment. Fasten it to the drive unit with the two screws.

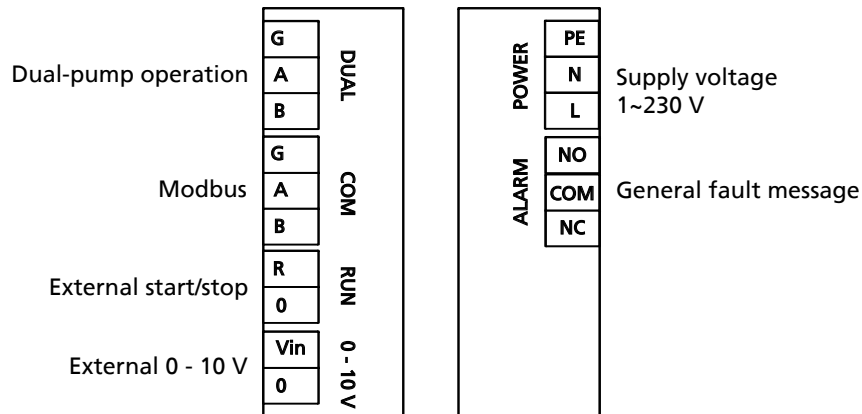

Fig. 9: Wiring diagram Magneta D Smedegaard 30-60/-100, 32-80/-120, 40-80/-100 and 50-80 ⁷⁾

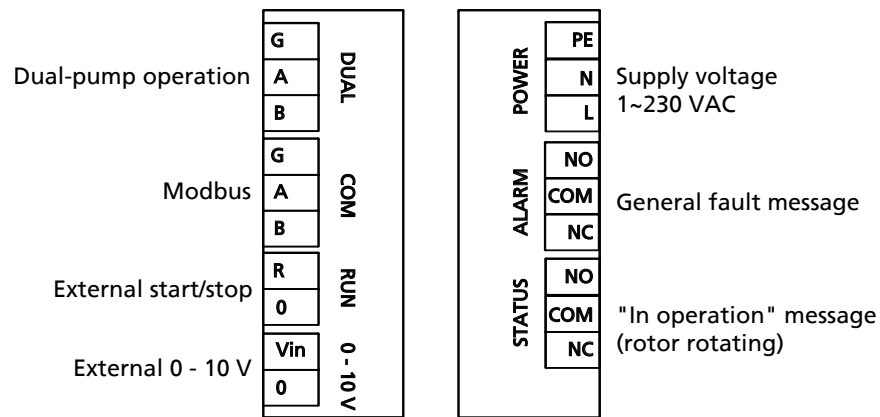

Fig. 10: Wiring diagram Magneta D Smedegaard 40-120/-180, 50-100/-120 and 65-80/-120

⁵⁾ Pump sizes 30-60/-100, 32-80/-120, 40-80/-100 and 50-80 are supplied without Modbus function.

⁶⁾ Integrated in pump sizes 40-120/-180, 50-100/-120 and 65-80/-120

⁷⁾ Pump sizes 30-60/-100, 32-80/-120, 40-80/-100 and 50-80 are supplied without Modbus function.

5.6.1 Routing the cables

- Route all low-voltage cables as direct as possible.
- Keep low-voltage cables separated from high-voltage cables, e.g. by metal partitions on cable trays.
- Only use shielded cables as low-voltage and bus cables.
- All bus cables must be routed in a line. Star topology is impermissible (see illustration).



NOTE

Use shielded bus cables of the stranded, twisted-pair type, e.g. CAT.5 (AWG23) or at least equivalent.



NOTE

When routing bus cables, prevent the formation of star points, e.g. in junction boxes. Loop the cables in/out at the devices in daisy-chain configuration.

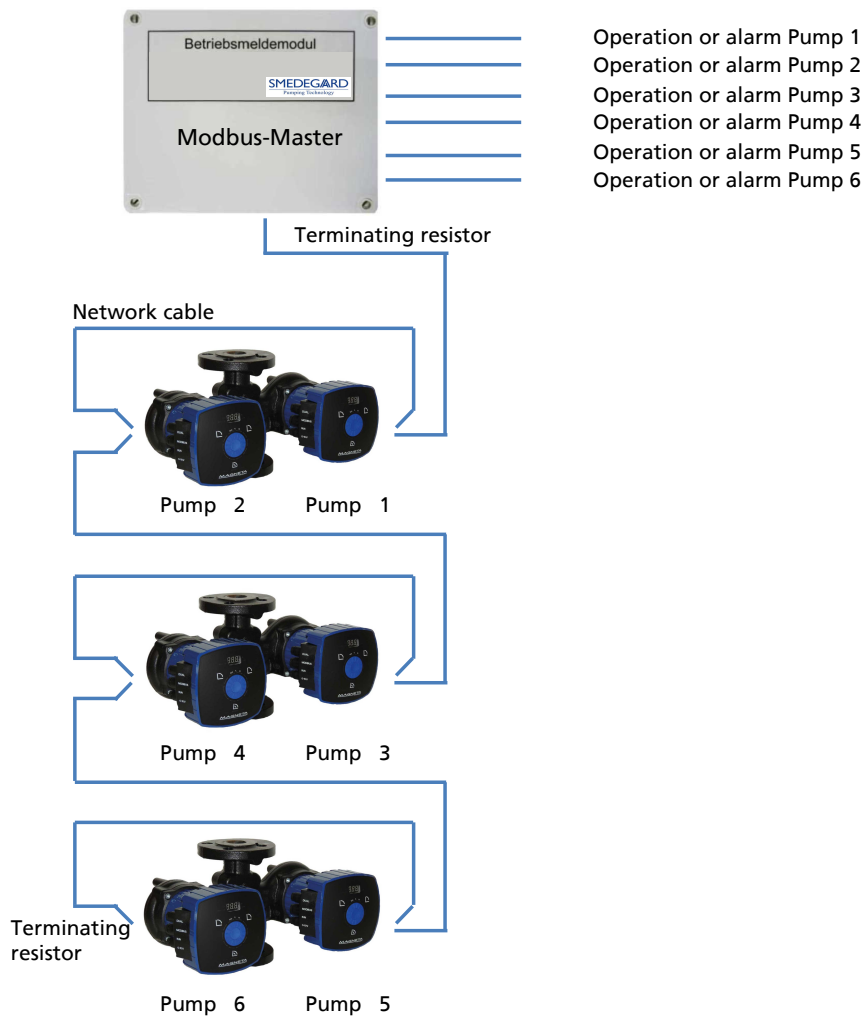

Fig. 11: Connecting the Magneta D Smedegaard pumps to operation signalling module 01550860



NOTE

The operation signalling module provides an operation or alarm message (general fault message) for a maximum of 6 pumps Magneta Smedegaard or 3 twin pumps Magneta D Smedegaard with a volt-free relay contact (see operating manual of the operation signalling module). Communication between the connected pumps and the operation signalling module is effected via Modbus. To this end, the pumps are wired at their Modbus terminals as illustrated (wiring in a line).

Make sure to use a network cable with a defined wave impedance (cable type B to TIA 485-A).

A suitable terminating resistor (120 Ohm) must be fitted at both cable ends. In the operation signalling module the terminating resistor is activated by setting DIP switch S1 to ON.

The operation signalling module 01550860 is the Modbus master, which controls the communication via Modbus. Neither the master nor the pumps can be connected to a higher-level automation system (building management system).



NOTE

Both pump heads must be connected via Modbus.

5.6.2 Terminating resistors in a Modbus system

Cable reflections occur at the open cable ends (first and last device of a bus system). The higher the selected baud rate, the larger their values. Provide terminating resistors to keep reflections to a minimum. The resistors will establish a defined rest potential.

- The bus cables between the Modbus devices must be arranged in a line.
- Prior to arranging the terminating resistors, de-energise the control unit.
- At the first and last Modbus device of a bus line, a terminating resistor must be connected between terminals "+" and "-".
- Resistance of the terminating resistor: 120 Ohm

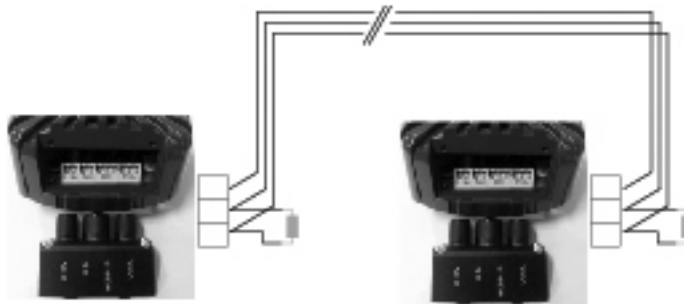

Fig. 12: Terminating resistors

6 Commissioning/Start-up/Shutdown

6.1 Commissioning/start-up

6.1.1 Prerequisites for commissioning/start-up

Before commissioning/starting up the pump set, make sure that the following conditions are met:

- The pump set has been properly connected to the power supply and is equipped with all protection devices.
- The pump has been primed with the fluid to be handled. The pump has been vented.

6.1.2 Priming and venting the pump



NOTE

The pumps are self-venting.



CAUTION

Increased wear due to dry running

Damage to the pump set!

- Never operate the pump set without liquid fill.
- Never close the shut-off element in the suction line and/or supply line during pump operation.

1. Prime the pump and suction line with the fluid to be handled.
2. Fully open the shut-off element in the suction line.

6.1.3 Start-up



⚠ DANGER

Non-compliance with the permissible pressure and temperature limits if the pump is operated with the suction and discharge lines closed.

Leakage of hot fluids!

- Never operate the pump with the shut-off elements in the suction line and/or discharge line closed.
- Only start up the pump set against a slightly or completely open discharge-side shut-off element.



⚠ DANGER

Excessive temperatures due to insufficient lubrication of shaft seal

Damage to the pump set!

- Never operate the pump set without liquid fill.
- Prime the pump as per operating instructions.
- Always operate the pump within the permissible operating range.



CAUTION

Abnormal noises, vibrations, temperatures or leakage

Damage to the pump!

- Switch off the pump (set) immediately.
- Eliminate the causes before returning the pump set to service.

- ✓ The system piping has been cleaned.
 - ✓ The pump, suction line and inlet tank, if fitted, have been vented and primed with the fluid to be pumped.
 - ✓ The lines for priming and venting have been closed.
1. Open the shut-off elements in the suction head/suction lift line.
 2. Switch on the power supply at both pumps.
 3. The initialisation process of the control modules at both pumps is carried out. The displays of both pumps show the dual-pump firmware symbol.



Fig. 13: Magneta D Smedegaard display - firmware test symbol

6.1.4 Operation

Operating elements

All settings are made using the dial on the housing front. To turn the dial, press the button in the middle of the dial.

10 LED segments are arranged around the dial. These segments represent setpoint values ranging from 10 % to 100 %. The LED segments light up in blue when pump settings are being made (the figure below shows a setpoint of 40 %).



NOTE

If set to 100 %, the performance limits may cause the actual value to be slightly below the maximum characteristic curve, depending on the pump and operating point.

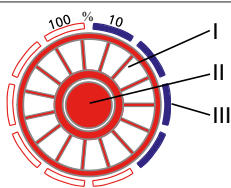

- | |
|--|
| I = dial |
| II = control button |
| III = 10 LED segments (lit up in blue when pump settings are being made) |

Display

Magna D Smedegaard 30-60/-100, 32-80/-120, 40-80/-100 and 50-80

The flow rate and the electrical input power are shown as 3-digit numbers on the integrated display. The display alternates in 5-second intervals between the two values in [m³/h] and [W] respectively. The flow rate is displayed as a number with one decimal place; the power input is displayed as a number without any decimal places. The setpoint is indicated in [%] without any decimal places.



Fig. 14: Magneta D Smedegaard display

Magneta D Smedegaard 40-120/-180, 50-100/-120 and 65-80/-120

Display

The flow rate, the electrical input power and the head are shown as 3-digit numbers on the integrated display. The display alternates in 5-second intervals between these values in [m³/h], [W] and [metres of water] respectively. The flow rate and the head are displayed as numbers with one decimal place; the power input is displayed as a number without any decimal places. The setpoint is indicated in [%] without any decimal places.







Fig. 15: Magneta D Smedegaard display

Symbols

The operating modes, functions and settings are indicated by symbols on the front panel. Lit symbols indicate which operating mode or function is active, whether an external 0 - 10 V signal is being transmitted and whether the pump is emitting a general fault message.

Table 9: Key to the symbols

Symbol	Description	Unit
m ³ /h	Flow rate (calculated) This symbol is lit when the flow rate value is shown on the display. (The display alternates in 5-second intervals between the flow rate and the electrical input power).	m ³ /h
m	Head (calculated)	metres of water
W	Electrical input power (measured) This symbol is lit when the power value is shown on the display. (The display alternates in 5-second intervals between the flow rate and the electrical input power).	W
	Constant-pressure Control operating mode This symbol is lit when this operating mode is active.	-
	Proportional-pressure Control operating mode This symbol is lit when this operating mode is active.	-
	Fixed Speed Operation operating mode This symbol is lit when this operating mode is active.	-
 ECO	ECO energy-saving mode Both these symbols are lit when this operating mode is active.	-
0 - 10 V	0 - 10 V operating mode This symbol is lit when this operating mode is active.	VDC
MODBUS	Modbus operating mode This symbol is lit when this operating mode is active.	-
DUAL	Dual-pump Operation operating mode This symbol is lit when this operating mode is active.	-
SERVICE	The pump signals a general fault message An error code is shown on the display. The display indicates error code E01 - E06.	-

6.1.4.1 Locking the control panel

Regardless of the operating mode the pump is in, its control panel can be locked with a second DIP switch in the wiring compartment of the pump to prevent unintentional changes of the setpoint, etc. If the **Control Panel Lock** function is enabled, the factory settings cannot be reset.

Table 10: Setting at the pump

Status of the Control Panel Lock function	Position of DIP switch 2 at the pump
= enabled	
= disabled	

Table 11: Function of the DIP switches

Function	DIP switch 1	DIP switch 2
Lock of pump control panel	-	x
Setback operation of pump	x	-

6.1.4.2 Resetting the factory setting

To reset the factory setting of the pump press the control button for more than 60 seconds. The pump loads the factory settings and then performs a re-set. This comprises the following settings:

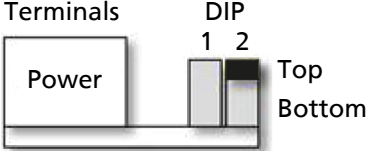
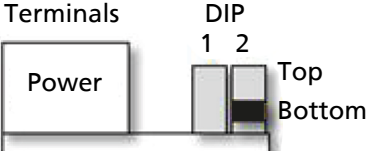
Operating mode	Proportional-pressure control
Functions	The Dual, Modbus, 0 - 10 V functions are disabled.
Setpoints	50 %
Modbus parameter baud rate	19,200 baud
Modbus parameter slave ID	17

6.1.5 Operating mode



CAUTION

Incorrect control mode of the pump

Damage to the pump!

- Make sure only one pump is operated at a time.



NOTE

If the DUAL mode is enabled, only one pump is operated at a time, regardless of the set operating mode. The second pump is on stand-by. It is only started up in the event of a pump changeover or a fault of the duty pump (redundancy). Pumps which are controlled by a higher-level automation system must only be operated in Fixed Speed Operation operating mode (Boost). For parallel operation, both pumps must always be operated at the same speed.

6.1.5.1 Information on settings

For common applications such as two-pipe systems Proportional-pressure Control ($\Delta p-v$) is the recommended operating mode. This operating mode offers an extended control range with additional potential savings compared to Constant-pressure Control ($\Delta p-c$). Depending on the balancing of branch circuits, undersupply may occur at a consumer installation.

The Constant-pressure Control operating mode ($\Delta p-c$) can be selected as an option (e.g. for underfloor heating systems). If noises are audible at low flow rates the Proportional-pressure Control operating mode ($\Delta p-v$) can be selected.

The setting of the discharge head setpoint depends on the piping curve of the system and on the heat requirements. As standard the pumps are set to Proportional-pressure Control ($\Delta p-v$) and maximum performance.

6.1.5.2 Constant-pressure control

Function

Irrespective of the flow rate, within the permissible flow rate range limited by the maximum pump characteristic ①, the pump control system maintains a constant pump head based on the set differential pressure setpoint H_s .

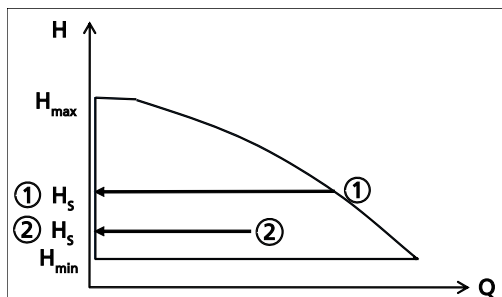

Fig. 16: Constant-pressure Control function

Setting

Activating the display from idle mode: Press the control button.

The display will show the current operating mode as well as, in alternation, the electrical input power and the flow rate. If 5 minutes pass without any settings being made or the control button being pressed, the display will revert to idle mode.

Table 12: Setting the operating mode to Constant-pressure Control and selecting the setpoint

	<p>Step 1: Activating the setting mode Press the control button for 3 seconds. The mode which has last been selected will start flashing.</p>
	<p>Step 2: Selecting the Constant-pressure Control operating mode Turn the dial until the symbol of the required operating mode starts flashing.</p>
	<p>Step 3: Activating the Constant-pressure Control operating mode Press the control button. The setpoint which has last been set will be indicated by means of the flashing blue LED segments.</p>

Confirming the current setpoint ⇒ Step 4a
 Changing the setpoint ⇒ Step 4b



Step 4a: Confirming the current setpoint
 Press the control button.



Step 4b: Changing the setpoint
 Turn the dial and set the required setpoint in increments of 1 % within the range from 0 % to 100 %. (Turning the dial clockwise will increase the setpoint; turning the dial anti-clockwise will decrease it). The LED segments will light up in increments of 10 % of the setpoint.
 Press the control button to save the setpoint.



NOTE

If 10 seconds pass without any settings being made or saved, the control unit will revert to the previous settings.

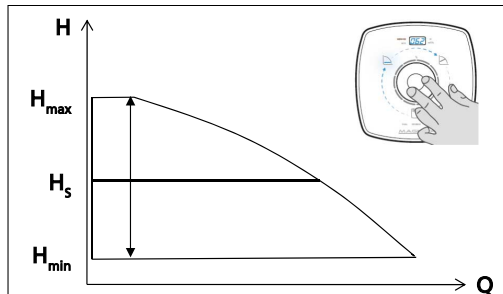

Fig. 17: Constant-pressure Control settings



NOTE

To start the pump the terminal pair "RUN" must be bridged (factory-set) or the terminal pair must receive the signal "Start".



Fig. 18: Terminal pair RUN

1 = 0

2 = R

6.1.5.3 Proportional-pressure control

Function

Within the permissible flow rate range the pump control system decreases or increases the differential pressure setpoint of the pump between $1/2 H_s$ and H_s (factory-set) in a linear fashion with the flow rate.

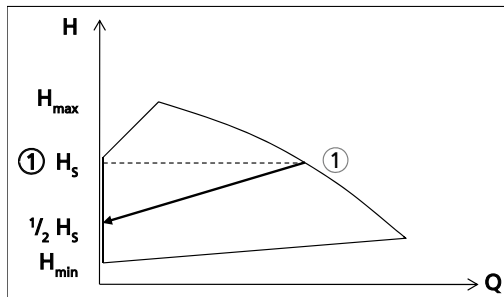

Fig. 19: Proportional-pressure Control function

Setting

Activating the display from idle mode: Press the control button.

The display will show the current operating mode as well as, in alternation, the electrical input power and the flow rate. If 5 minutes pass without any settings being made or the control button being pressed, the display will revert to idle mode.

Table 13: Setting the operating mode to Proportional-pressure Control and selecting the setpoint

	<p>Step 1: Activating the setting mode Press the control button for 3 seconds. The mode which has last been selected will start flashing.</p>
	<p>Step 2: Selecting the Proportional-pressure Control operating mode Turn the dial until the symbol of the required operating mode starts flashing.</p>
	<p>Step 3: Activating the Proportional-pressure Control operating mode Press the control button. The setpoint which has last been set will be indicated by means of the flashing blue LED segments.</p>
<p>Confirming the current setpoint ⇒ Step 4a Changing the setpoint ⇒ Step 4b</p>	
	<p>Step 4a: Confirming the current setpoint Press the control button.</p>
	<p>Step 4b: Changing the setpoint Turn the dial and set the required setpoint in increments of 1 % within the range from 0 % to 100 %. (Turning the dial clockwise will increase the setpoint; turning the dial anti-clockwise will decrease it). The LED segments will light up in increments of 10 % of the setpoint. Press the control button to save the setpoint.</p>



NOTE

If 10 seconds pass without any settings being made or saved, the control unit will revert to the previous settings.

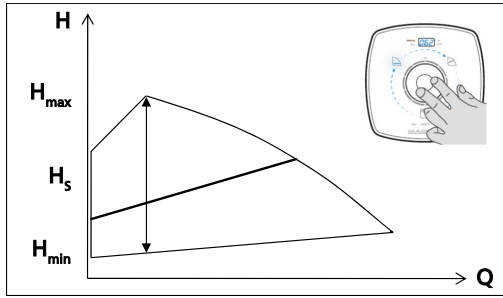

Fig. 20: Proportional-pressure Control settings



NOTE

To start the pump the terminal pair "RUN" must be bridged (factory-set) or the terminal pair must receive the signal "Start".



Fig. 21: Terminal pair RUN

1 = 0
2 = R

6.1.5.4 Fixed speed operation

Fixed Speed Operation function

The pump is operated at the set speed level (characteristic curve). The speed can be set to one of 100 levels. In the example (see Fig. Fixed Speed Operation settings) the pump is operated at speed level 2.

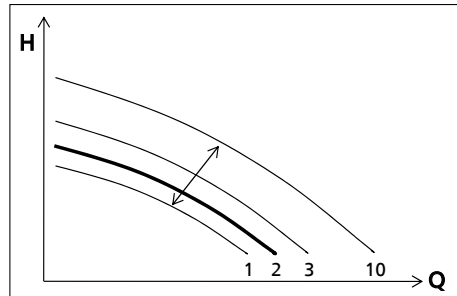



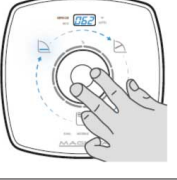



Fig. 22: Fixed Speed Operation function

Setting

Activating the display from idle mode: Press the control button.

The display will show the current operating mode as well as, in alternation, the electrical input power and the flow rate. If 5 minutes pass without any settings being made or the control button being pressed, the display will revert to idle mode.

Table 14: Setting the operating mode to Fixed Speed Operation and selecting the setpoint

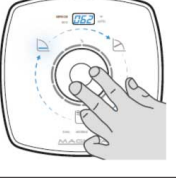
	<p>Step 1: Activating the setting mode Press the control button for 3 seconds. The mode which has last been selected will start flashing.</p> 
	<p>Step 2: Selecting the Fixed Speed Operation operating mode Turn the dial until the symbol of the required operating mode starts flashing.</p> 
	<p>Step 3: Activating the Fixed Speed Operation operating mode Press the control button. The setpoint which has last been set will be indicated by means of the flashing blue LED segments.</p>
<p>Confirming the current setpoint ⇒ Step 4a Changing the setpoint ⇒ Step 4b</p>	
	<p>Step 4a: Confirming the current setpoint Press the control button.</p>
	<p>Step 4b: Changing the setpoint Turn the dial and set the required setpoint in increments of 1 % within the range from 0 % to 100 %. (Turning the dial clockwise will increase the setpoint; turning the dial anti-clockwise will decrease it). The LED segments will light up in increments of 10 % of the setpoint. Press the control button to save the setpoint.</p>

 **NOTE**
If 10 seconds pass without any settings being made or saved, the control unit will revert to the previous settings.

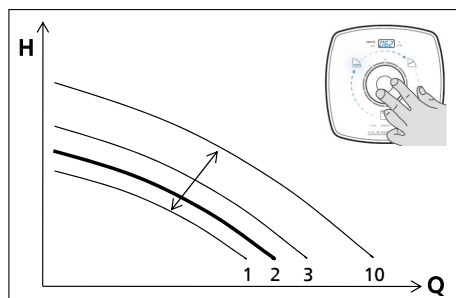

Fig. 23: Fixed Speed Operation settings

 **NOTE**
To start the pump the terminal pair "RUN" must be bridged (factory-set) or the terminal pair must receive the signal "Start".



Fig. 24: Terminal pair RUN

1 = 0
2 = R

6.1.5.5 Eco Mode

Function

In Eco Mode the pump characteristic curve (4) is quadratic, starting at the discharge head setpoint $H_{Eco\ Start} = 1/4 \times H_S$ with $H_S =$ selected setpoint (see Setting the operating mode to **Proportional-pressure Control**). By changing the differential pressure setpoint the pump characteristic curve can be adjusted to higher or lower differential pressures or discharge heads. Compared with the **Proportional-pressure Control** operating mode the Eco Mode can save more than 40 % in electrical input power.

The various pump characteristic curves and control ranges are illustrated in Fig. Eco Mode – Characteristic curve, example of a size 25-100 pump.

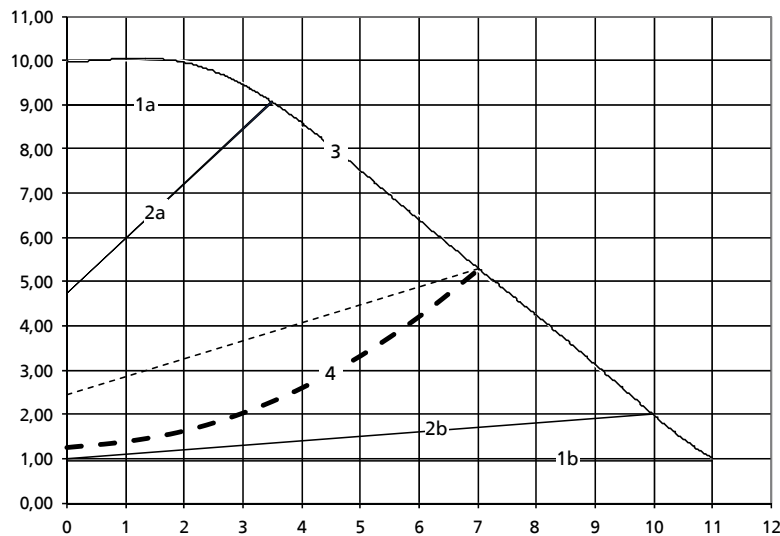

Fig. 25: Eco Mode – Characteristic curve, example of a size 25-100 pump







1a	Upper limit of constant-pressure control
1b	Lower limit of constant-pressure control
2a	Upper limit of proportional-pressure control
2b	Lower limit of proportional-pressure control
3	Maximum characteristic curve
4	Eco Mode characteristic curve

Setting

Activating the display from idle mode: Press the control button.

The display will show the current operating mode as well as, in alternation, the electrical input power and the flow rate. If 5 minutes pass without any settings being made or the control button being pressed, the display will revert to idle mode.

Table 15: Setting the operating mode to Eco Mode and selecting the setpoint

	<p>Step 1: Activating the setting mode Press the control button for 3 seconds. The mode which has last been selected will start flashing.</p> 
	<p>Step 2: Selecting the Eco Mode operating mode Turn the dial until the symbol of the required operating mode starts flashing.</p> <p>ECO</p>
	<p>Step 3: Activating the Eco Mode operating mode Press the control button. The setpoint which has last been set will be indicated by means of the flashing blue LED segments.</p>
<p>Confirming the current setpoint ⇒ Step 4a Changing the setpoint ⇒ Step 4b</p>	
	<p>Step 4a: Confirming the current setpoint Press the control button.</p>
	<p>Step 4b: Changing the setpoint Turn the dial and set the required setpoint in increments of 1 % within the range from 0 % to 100 %. (Turning the dial clockwise will increase the setpoint; turning the dial anti-clockwise will decrease it). The LED segments will light up in increments of 10 % of the setpoint. Press the control button to save the setpoint.</p>



NOTE

If 10 seconds pass without any settings being made or saved, the control unit will revert to the previous settings.



NOTE

To start the pump the terminal pair "RUN" must be bridged (factory-set) or the terminal pair must receive the signal "Start".



Fig. 26: RUN terminal pair

1 = 0
2 = R

6.1.5.6 0 - 10 V

Function

An external analog 0 - 10 VDC signal serves as external setpoint input for the pump. The pump processes the current external analog signal as a differential pressure setpoint if the **Constant-pressure Control** or **Proportional-pressure Control** operating modes are active, or as speed setpoint if the **Fixed Speed Operation** operating mode is active. At signal levels < 2 VDC the pump stops. The last LED segment extinguishes.

Table 16: Setpoint settings at the pump for signal level 0 - 10 V

Signal level of 0 - 10 V signal	Setpoint setting at the pump
10 VDC	100 % of the setpoint
2 VDC	0 % of the setpoint
< 2 VDC	Pump stops
≥ 2 VDC	Pump starts up

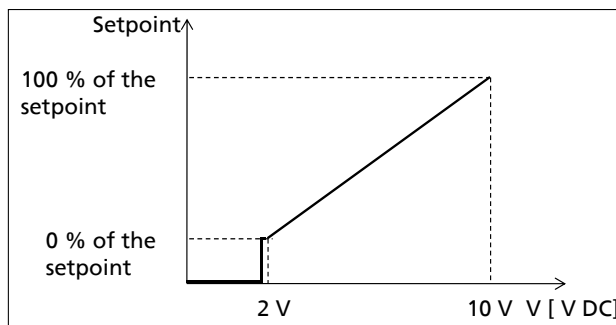

Fig. 27: Analog 0 - 10 V signal as setpoint for the pump

Setting

The external analog signal is wired to the terminal pair "0 - 10 V" integrated in the pump.



NOTE

In Dual-pump operating mode the external analog "0 - 10 V" signal has to be wired to both pumps to maintain the duty point after a pump changeover.

Activating the display from idle mode: Press the control button.

The display will show the current operating mode as well as, in alternation, the electrical input power and the flow rate. If 5 minutes pass without any settings being made or the control button being pressed, the display will revert to idle mode.

Table 17: Activating/de-activating the 0 - 10 V operating mode and setting the setpoint

	<p>Step 1: Enabling the sub-mode (DUAL, Modbus, 0 - 10 V) Press the control button for 6 seconds. One of the symbols representing the Dual-pump Operation (DUAL), Modbus and 0 - 10 V sub-modes will start flashing.</p>
	<p>Step 2: Selecting the 0 - 10 V operating mode Turn the dial until the symbol of the required operating mode starts flashing. 0 - 10 V</p>



Step 3: Activating or de-activating the 0 - 10 V operating mode
 Press the control button.
 The symbol will light up. When the signal is activated, the circular segments will indicate the value of the input signal.



NOTE

If 10 seconds pass without any settings being made or saved, the control unit will revert to the previous settings.

Table 18: LED segments per signal level [V]

Lit LED segment	Voltage
0	2,4
1	3,2
2	4,0
3	4,8
4	5,6
5	6,4
6	7,2
7	8,0
8	8,8
9	9,6
10	10,0

The external analog signal is wired to the terminal pair "0 - 10 V" integrated in the pump.



NOTE

To start the pump the "RUN" terminal pair must be bridged (factory setting) or the terminal pair must receive the "Start" signal.
 In Dual-pump operating mode the RUN contact at both pumps must be bridged to enable a pump changeover.



Fig. 28: RUN terminal pair

1 = 0
2 = R

6.1.5.7 Functions

6.1.5.7.1 Setback operation



⚠ DANGER

Work at the DIP switch by unqualified personnel

Danger of death from electric shock!

- The pump must be de-energised before the Setback Operation function can be enabled/disabled at DIP switch 1.



Function

When the fluid temperature has been sinking continuously the pump recognises minimum heating requirements. If the **Setback Operation** function is enabled, the pump automatically switches to operation at minimum speed and also reduces the speed of the circular running light. When the setpoint is changed, the pump changes from Setback Operation to its previous operating mode. When the demand on heating performance rises again, the pump automatically returns to its previous operating mode. Unless the **0 - 10 V** function is active, the **Setback Operation** function can be enabled in all operating modes via DIP switch 1 (the function is enabled with DIP switch 1 in top position).



NOTE

This function is disabled in the factory setting.

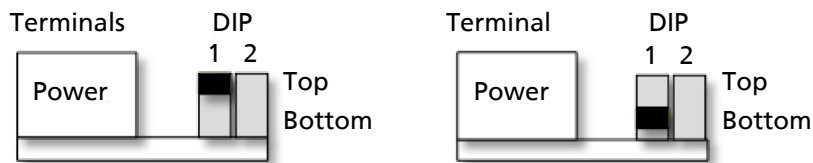

Fig. 29: Position of DIP switch 1

Position of DIP switch 1	Setback Operation function
Top	Enabled
Bottom	Disabled

Prerequisites:

1. The pump is installed in the supply line.
2. The Setback Operation function must be enabled in the higher-level control system (this will reduce the supply temperature).

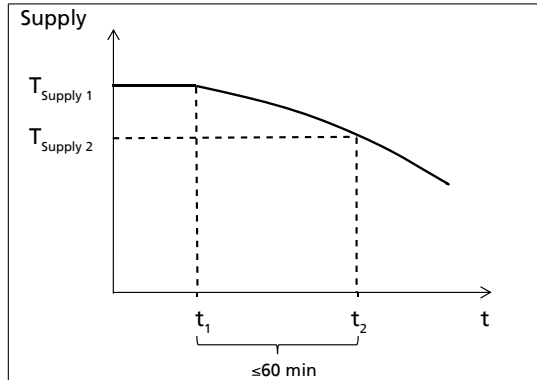

Fig. 30: Setback operation

6.1.5.7.2 Dual-pump Operation (DUAL function)

Setting

The control modules of the two pumps are connected with a commercial, shielded data cable. The terminals of the RUN terminal pair must be bridged at both pumps.



NOTE

The settings of the connected pumps can differ. Each pump is operated in accordance with its settings. For example, one pump can be operated in closed-loop control mode and the other in Fixed Speed Operation mode.

To ensure that the changeover from duty pump to stand-by pump will not have any impact on the duty point and operating mode, the settings and wiring of both pumps must be identical.

Activating the display from idle mode: Press the control button. The display will show the current operating mode as well as, in alternation, the electrical input power and the flow rate. If 5 minutes pass without any settings being made or the control button being pressed, the display will revert to idle mode.

Table 19: Activating/de-activating the Dual-pump Operation (DUAL) operating mode

	<p>Step 1: Enabling the sub-mode (DUAL, Modbus, 0 - 10 V) Press the control button for 6 seconds. One of the symbols representing the Dual-pump Operation (DUAL), Modbus and 0 - 10 V sub-modes will start flashing.</p>
	<p>Step 2: Selecting the Dual-pump Operation (DUAL) operating mode Turn the dial until the symbol of the required operating mode starts flashing. DUAL</p>
	<p>Step 3: Activating or de-activating the Dual-pump Operation (DUAL) operating mode Press the control button. The symbol will light up.</p>



NOTE

If 10 seconds pass without any settings being made or saved, the control unit will revert to the previous settings.

Function

A few seconds after both pumps have started up, the duty/stand-by operating mode becomes active and stops one of the pumps. The pump which remains active (on duty) is operated at 0 - 100 %; the other pump is on stand-by.

The **External Start/Stop** function will be deactivated for the stand-by pump, irrespective of the wiring of the RUN terminal pair.

The duty pump can be controlled by means of the **0 - 10 V** operating mode or the integrated **External Start/Stop** function.

The wiring of the External Start/Stop function and the external analog signal must be identical at the duty pump and stand-by pump to maintain the function/operating mode after a pump changeover.

Automatic pump changeover (1)

The pumps come with an integrated timer, which switches off the duty pump after 24 hours of operation and starts up the stand-by pump. To this effect, before the duty pump is switched off it signals a start command to the stand-by pump. The stand-by pump will be started up and the first pump will be stopped.

Precondition:

The RUN contact of the stand-by pump is enabled/bridged.

Redundant operation (2)

In the event of a failure of the duty pump the stand-by pump will be started up automatically and will take over the functions of the failed pump.

Precondition:

The RUN contact of the stand-by pump is enabled/bridged.

The two functions (1) and (2) will be carried out automatically.

6.1.5.7.3 Connection to bus systems with Modbus

Table 20: Technical data of the Modbus interface

Parameter	Description/value
Terminal cross-section	1.5 mm ²
Interface	RS485 (TIA-485A) optically isolated
Bus connection	Shielded bus cable, twisted in pairs, 1x 2x 0.5 mm ²
Cable length	1000 m maximum, stub lines impermissible, for cable lengths > 30 m take suitable measures to prevent overvoltages.
Wave impedance	120 Ohm (cable type B to TIA 485-A)
Data rates [baud]	2,400/4,800/9,600/19,200 (factory setting)
Protocol	Modbus RTU standard
Data format	8 data bits, EVEN parity, 1 stop bit
Modbus address	ID #17 (factory setting)

Function

Both pumps come with the **Modbus** function and the corresponding Modbus terminal pair integrated in the control module. The pumps are Modbus slaves and only respond to the Modbus master (external hardware and software). The pump can neither be set nor operated as a Modbus master. The send and receive commands comply with the requirements of the standard protocol Modbus RTU.

Neither the bus cable nor the hardware and software of a Modbus master are included in the pumps' scope of supply.

Connection

Remove the cover of the terminal wiring compartment. Connect the bus cable (shielded, 2-core, 0.5 mm²) to terminal pair A and B of the three-piece Modbus terminal.

Terminal G is connected to ground. The shield of the bus cable can be connected to this terminal, for example. The terminals are suitable for cable cross-sections of up to 1.5 mm².



NOTE

Both pump heads must be connected to Modbus; an internal data exchange between both the control modules will not take place.

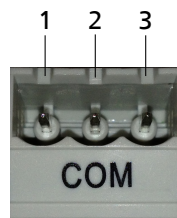

Fig. 31: COM terminal pair

1	B (signal conductor)
2	A (signal conductor)
3	G (ground)

All Modbus data points can be read at all times (monitoring) without having to disable the **Modbus** function at the pump. All data points are listed below. Before the pump can receive and respond to any Modbus input, the **Modbus** function has to be enabled at the pump (see settings). The Modbus input is overwritten by any input made at the site (manual input at the pump), an external analog signal (**0 - 10 V** function), a bridged RUN terminal pair, and the **External Start/Stop** function. The pump assigns the following priorities to the various types of input.

Table 21: Priorities

Priority	Function/input
1	Input via the External Start/Stop function or a bridged RUN terminal pair
2	Setpoint input via the 0 - 10 V function
3	Manual setpoint input on site at the control panel
4	Modbus input

Regardless of whether the pump is receiving input of priority 1, 2 or 3, it will only start up when the RUN terminal pair is bridged or when this terminal pair receives such a signal (provided that the pump is connected to an appropriate voltage supply).



NOTE

The pump is delivered with the terminal pair RUN bridged.

This allows the **Modbus** and **0 - 10 V** functions to be activated at the pump in parallel, for example. The input is processed by the pump in the order of priorities indicated above.

If the **Modbus** as well as **DUAL** (Dual-pump Operation) functions are active, both single pumps must be connected to Modbus as changes made to the settings of the duty pump will not be transferred to the stand-by pump via the DUAL terminal pair.

If the **DUAL** function is active, the pumps are automatically changed over every 24 hours of (uninterrupted) operating time; in the event of a failure of the duty pump, the stand-by pump will take over the function of the duty pump. For this reason, the Modbus input must be identical for both pumps to ensure that each duty pump will reach the required operating point.

If only one of the two pumps is connected to Modbus, this pump can receive new input via Modbus. However, this input will not be transferred to the second pump via the terminal pair DUAL. The parameters of the two pumps may differ in this case, and the operating point may no longer be reached after pump changeover.

If the **Modbus** function has been de-activated, active Modbus input will no longer be processed by the control module. Instead, the previously active local input functions will be re-activated. When returning to the Modbus operating mode, the Modbus input must be re-written and re-sent by the control station.

Data points

Data points of type R are read-only; data points of type R/W are read & write enabled.

Table 22: Overview of Modbus operating parameters

Parameter description	Register	Length [byte]	Type/format	Unit	Access
Error vector, bit code	07 D0	00 02	INT16	Bit 0 = error code E01 Bit 1 = error code E02 Bit 2 = error code E03 Bit 3 = error code E04 Bit 4 = error code E05 Bit 5 = error code E06 (error codes see "Key to the error vectors" table)	R
Calculated head	07 D2	00 02	INT16	Head in m x 10	R
Calculated flow rate	07 D4	00 02	INT16	Flow rate in m ³ /h x 10	R
Current speed	07 D8	00 02	UINT16	Speed in rpm	R



Parameter description	Register	Length [byte]	Type/format	Unit	Access
Pump status	07 D9	00 02	UINT16	0 = Pump stop 1 = Pump in operation	R
Operating hours, pump	07 DA	00 02	INT16	Operating hours	R
Power pump	07 DC	00 02	INT16	Watt	R
Current pump load	07 DE	00 02	UINT16	Value between 0 and 100 %	R
Operating mode selection	08 34	00 01	ENUM	1 = Constant-pressure Control 4 = Proportional-pressure Control (factory setting) 8 = Eco Mode 16 = Fixed Speed Operation	R/W
Setpoint input	08 35	00 02	UINT16	0 - 9999 equals 0 - 100 % of the setpoint	R/W
Pumps start/stop	08 36	00 01	ENUM	0x05 = pump stop 0xA0 = pump start (cannot overwrite the external RUN contact)	R/W
Modbus baud rate	0B B8	00 01	ENUM	0 = 9,600 3 = 9,600 4 = 19,200 (factory setting)	R/W
Modbus address	0B B9	00 02	UINT16	0 - 240, default address 17	R/W

Function	Function code
Read	Function code 03 (0x03 read holding registers)
Write	Function code 16 (0x10 write multiple registers)

All registers (07 D0 ... 07 DE) can be read out via function code 0x03 (read holding registers) as one unit.

Table 23: Key to the error vectors

Error vector	Description	Bit
E01	Temperature limit exceeded	0
E02	Overcurrent	1
E03	Internal fault	2
E04	Rotor blocked	3
E05	Overload / adjusted speed	4
E06	Supply voltage too high/low	5



NOTE

Error E05 is a warning. The pump will not stop but reduce its speed until no overload is detected any more.

Examples of Modbus communication

- Monitoring the speed:
To be able to read the current speed of the pump, the following request has to be sent by the master: Modbus Request 11 03 07 D8 00 01 07 D5
- Setpoint input:
The setpoint can be set to any value from 0 - 9999, with 9999 equalling 100 % of the setpoint.
Example: Write setpoint 50 %
Modbus Request 11 10 08 35 00 01 02 13 88 EA A3
- Input control mode:
The operating mode of the pump can also be changed via Modbus (see table).
Example: Write Fixed Speed Operation control mode
Modbus Request 11 10 08 34 00 01 02 00 10 E7 E8



Setting

The pump can be connected to a Modbus network with a commercial, shielded data cable. The procedure below describes how to activate/de-activate the **Modbus** operating mode.

Activating the display from idle mode: Press the control button.

The display will show the current operating mode as well as, in alternation, the electrical input power and the flow rate. If 5 minutes pass without any settings being made or the control button being pressed, the display will revert to idle mode.

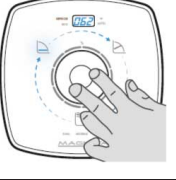
Table 24: Activating/de-activating the Modbus operating mode

	<p>Step 1: Enabling the sub-mode (DUAL, Modbus, 0 - 10 V) Press the control button for 6 seconds. One of the symbols representing the Dual-pump Operation (DUAL), Modbus and 0 - 10 V sub-modes will start flashing.</p>
	<p>Step 2: Selecting the Modbus operating mode Turn the dial until the symbol of the required operating mode starts flashing. MODBUS</p>
	<p>Step 3: Activating or de-activating the Modbus operating mode Press the control button. The symbol will light up.</p>

The Modbus address of the pump is set in the Modbus master (e.g. by connecting a laptop with Modbus master functionality and providing the pump with the corresponding input).



NOTE

If 10 seconds pass without any settings being made or saved, the control unit will revert to the previous settings.

6.1.5.7.4 External start/stop

Function

The pump is started up/stopped as a function of an external signal.

To determine the status of the transferred signal, one of the two terminals is internally supplied with a low voltage. The voltage at both terminals of the pair is measured against a common earthing point. The measurement at the second terminal of the pair will indicate the voltage drop.

Table 25: Pump start and stop

Measured voltage drop	Effect
0	Pump starts up (contact closed / terminals bridged)
> 0	Pump stops (contact open / terminals not bridged)

Setting

The external signal is wired to the RUN terminal pair integrated in the pump.



NOTE

To start the pump the "RUN" terminal pair must be bridged (factory setting) or the terminal pair must receive the "Start" signal.
In Dual-pump operating mode the RUN contact at both pumps must be bridged to enable a pump changeover.



Fig. 32: RUN terminal pair

1 = 0
2 = R

6.1.5.7.5 Saving data

Function

The operating data of the pump are saved. Data storage will be maintained also when the pump is stopped or de-energised. Once the pump is switched on again it will be operated with the data and duty point that were active before the pump was last stopped.

Settings

None

6.1.5.7.6 Deblocking the impeller

Function

The pump is started up at maximum torque to remove any hydraulic blocking which may occur (at the impeller or motor shaft). The pump input power is limited in this case (protective function). If the blocking cannot be removed, the pump will stop the start-up attempt and display error code E04. After a short break the pump will try to start up again. The number of start-up attempts is unlimited. Once the pump has started up successfully, it will acknowledge the error message; error code E04 will disappear from the display.

Settings

None

6.1.5.7.7 Protective functions

Function

The electronic motor protection automatically reduces the pump power in the event of overloading. Warning E05 is shown on the display.

Settings

None

6.1.5.7.8 Alerts

Function

To protect the pump from destruction it is stopped in the event of severe errors (E01 - E04, E06).

The integrated relay with a volt-free NC and a volt-free NO contact can be used as a general fault message.

Table 26: Error codes, causes and response

Error code on the pump display	Cause	Response
E01	Overheating	The pump is stopped
E02	Overcurrent	The pump is stopped
E03	Internal fault	The pump is stopped
E04	Rotor blocked	The pump is stopped
E05	Rise in temperature	Speed is reduced
E06	Voltage error	The pump is stopped

Setting

The signal is wired to the terminal pair Alarm with terminals NO/COM/NC.

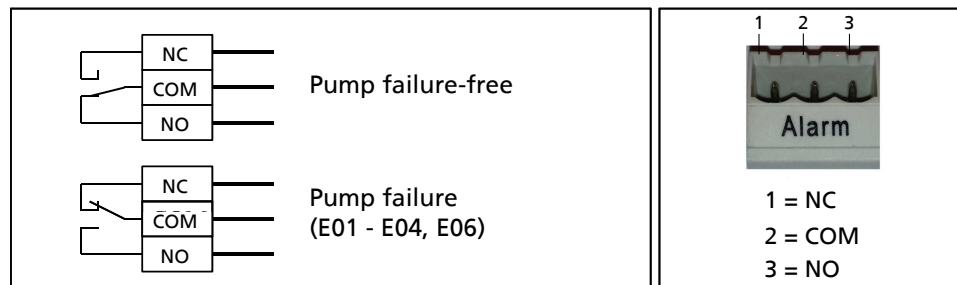

Fig. 33: Wiring diagram for the alarm message



NOTE

In Dual-pump Operation operating mode the alarm signal and the "in operation" message must be wired separately for each pump.

6.1.5.7.9 "In operation" message

Pumps of sizes 40-120/-180, 50-100/-120 and 65-80/-120 signal their operational status via the integrated, volt-free relay contact.

Pump not in operation = rotor not rotating, no flow

Pump in operation = rotor rotating

This information can be accessed at the "status" terminal pair with terminals NO/COM/NC.

Wiring diagram see



NOTE

In Dual-pump Operation operating mode the alarm signal and the "in operation" message must be wired separately for each pump.

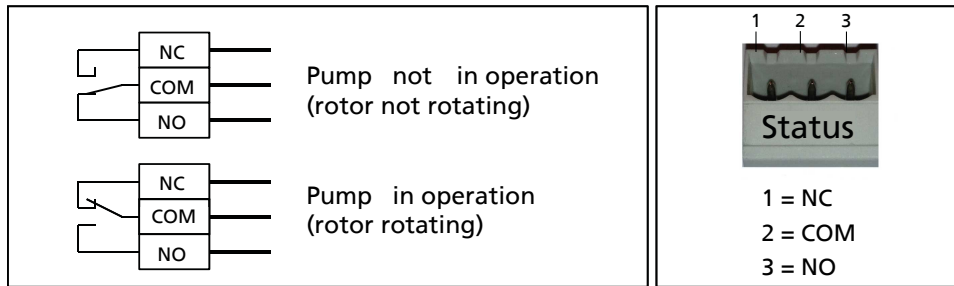

Fig. 34: Wiring diagram for "in operation" message

6.2 Shutdown

- ✓ The shut-off element in the suction line is and remains open.
- 1. Close the shut-off element in the discharge line.
- 2. Switch off the motor and make sure the pump set runs down smoothly to a standstill.



NOTE

If the discharge line is equipped with a check valve, the shut-off element in the discharge line may remain open, provided the site's requirements and regulations are taken into account and observed.

For prolonged shutdown periods:

- 1. Close the shut-off element in the suction line.



CAUTION

Risk of freezing during prolonged pump shutdown periods

Damage to the pump!

- Drain the pump and the cooling/heating chambers (if any) or otherwise protect them against freezing.

6.3 Operating limits



⚠ DANGER

Non-compliance with operating limits for pressure, temperature, fluid handled and speed

Hot fluid may escape!

- Comply with the operating data indicated in the data sheet.
- Avoid prolonged operation against a closed shut-off element.
- Never operate the pump at product temperatures exceeding those specified in the data sheet or on the name plate.

6.3.1 Ambient temperature



CAUTION

Operation outside the permissible ambient temperature

Damage to the pump (set)!

- Observe the specified limits for permissible ambient temperatures.

Observe the following parameters and values during operation:

Table 27: Fluid temperature specified for the ambient temperature [°C]

	Fluid temperature	Ambient temperature
All	110	30
	90	40

6.3.2 Density of the fluid handled

The pump input power changes in proportion to the density of the fluid handled.



CAUTION

Impermissibly high density of the fluid handled

Motor overload!

➤ Observe the information on fluid density in the data sheet.

6.4 Shutdown/storage/preservation

6.4.1 Measures to be taken for shutdown

The pump (set) remains installed

- ✓ Sufficient fluid is supplied for the operation check run of the pump.
- 1. Start up the pump (set) regularly between once a month and once every three months for approximately five minutes during prolonged shutdown periods.
This will prevent the formation of deposits within the pump and the pump intake area.

The pump is removed from the pipe and stored

The pump has been properly drained [⇒ Section 7.2, Page 50] and the safety instructions for dismantling the pump have been observed.

Observe any additional instructions and information provided. [⇒ Section 3, Page 10]

6.5 Returning to service

For returning the pump to service observe the sections on commissioning/start-up and the operating limits.

In addition, carry out all servicing/maintenance operations before returning the pump (set) to service.



WARNING

Failure to re-install or re-activate protective devices

Risk of injuries by escaping fluid!

➤ As soon as the work is completed, re-install and/or re-activate any safety-relevant and protective devices.

7 Servicing/Maintenance

7.1 Servicing/inspection

The circulator pumps are almost maintenance-free.
If the pump has not been in operation for a prolonged period of time or if the system is severely contaminated, the rotor can become locked.



NOTE

Any repairs on the pump must only be performed by one of our authorised service partners.
In the event of a failure, please contact your heating system engineer.

7.2 Drainage/cleaning



WARNING

Fluids, consumables and supplies which are hot and/or pose a health hazard

Hazard to persons and the environment!

- Collect and properly dispose of flushing fluid and any residues of the fluid handled.
- Wear safety clothing and a protective mask, if required.
- Observe all legal regulations on the disposal of fluids posing a health hazard.

1. Always flush the pump if it has been used for handling noxious, hot or other hazardous fluids.
Always flush and clean the pump before transporting it to the workshop. Provide a cleaning record for the pump.

7.3 Removing the pump set from the piping

7.3.1 Dismantling the complete pump set



DANGER

Work performed on an energised terminal box

Danger of death from electric shock!

- Switch off the supply voltage at least 5 minutes prior to commencing work and ensure that it cannot be switched on again unintentionally.



DANGER

Strong magnetic field in the rotor area

Danger of death for persons with pacemaker!

- Keep a safety distance of at least 0.3 m.



⚠ DANGER

Pump acting as a generator when running in reverse

Danger to life from hazardous induction voltage at the motor terminals!

- Prevent the fluid from flowing back by closing the shut-off elements.



⚠ WARNING

Danger by strong magnetic field

Danger of crushing injuries when pulling out the rotor!

Due to the strong magnetic field the rotor can be suddenly pulled back into its original position!

Danger of magnetic parts near the rotor being attracted!

- The rotor must generally only be removed from the motor housing by authorised specialist personnel.
- Remove any magnetic parts from the vicinity of the rotor.
- Keep the assembly area clean.
- Keep a safety distance of at least 0.3 m from electronic components.



CAUTION

Strong magnetic field in the rotor area

Interference with magnetic data carriers, electronic devices, components and instruments!

Uncontrolled magnetic attraction forces between magnetic components, tools or similar!

- Remove any magnetic parts from the vicinity of the rotor.
- Keep the assembly area clean.



CAUTION

Danger by strong magnetic field

Negative impact on or damage to electrical devices!

- The rotor must generally only be removed from the motor housing by authorised specialist personnel.

- ✓ The relevant notes and steps stated have been observed/carried out.
 - ✓ The pump has cooled down to ambient temperature.
 - ✓ A container for collecting the fluid has been positioned underneath the pump set.
1. De-energise the pump set (disconnect the motor) and ensure that it cannot be re-energised unintentionally.
 2. Close the shut-off elements.
 3. Disconnect the discharge and suction nozzles from the piping.
 4. Depending on the pump/motor size, remove the supports from the pump set.
 5. Remove the complete pump set from the piping.

8 Trouble-shooting



WARNING

Improper work to remedy faults

Risk of injury!

- For any work to remedy faults observe the relevant information in this manual or in the relevant accessory manufacturer's product literature.

If problems occur that are not described in the following table, consultation with the customer service is required.

- A** Pump is running but does not deliver
- B** Pump starts up but stops again immediately

E01 Error code on the display

E02 Error code on the display

E03 Error code on the display

E04 Error code on the display

E05 Error code on the display

E06 Error code on the display

E08 Error code on the display

Table 28: Trouble-shooting

A	B	E01	E02	E03	E04	E05	E06	E08	Possible cause	Remedy [®]
x	-	-	-	-	-	-	-	-	Master switch OFF, defective fuse, earth conductor not or incorrectly connected	Check master switch. Check fuse. Check pump connection.
-	x	-	-	-	-	-	-	-	Remote start/stop contact has been removed.	Fit connecting bridge for start/stop function.
-	-	x	-	-	-	-	-	-	Overheating	Let the pump cool down for some minutes. Then try to re-start it. Verify that the water and ambient temperature are within the indicated temperature ranges.
-	-	-	x	-	-	-	-	-	Overcurrent	Disconnect the pump from the power supply (for 1 minute). Then re-connect it to the power supply.
-	-	-	-	x	-	-	-	-	Internal fault	Disconnect the pump from the power supply (for 1 minute). Then re-connect it to the power supply.
-	-	-	-	-	x	-	-	-	Rotor blocked	Start up and stop the pump several times. If the pump is still blocked, properly dismantle and deblock it.
-	-	-	-	-	-	x	-	-	Rise in temperature	To prevent a temperature increase inside the pump the speed has been reduced. Once the pump has cooled down, it will revert to its normal operating data. If the temperature continues to rise, E01 will be indicated on the display.
-	-	-	-	-	-	-	x	-	Voltage error	Verify that the voltage matches the data on the name plate.

A	B	E01	E02	E03	E04	E05	E06	E08	Possible cause	Remedy ⁸⁾
-	-	-	-	-	-	-	-	X	Motor fault	Disconnect the pump from the power supply (for 1 minute). Then re-connect it to the power supply. If not remedied, have the motor checked by DP Service.

⁸⁾ Release pump pressure before attempting to remedy faults on parts which are subjected to pressure.



9 Related Documents

9.1 Sectional drawing with list of components

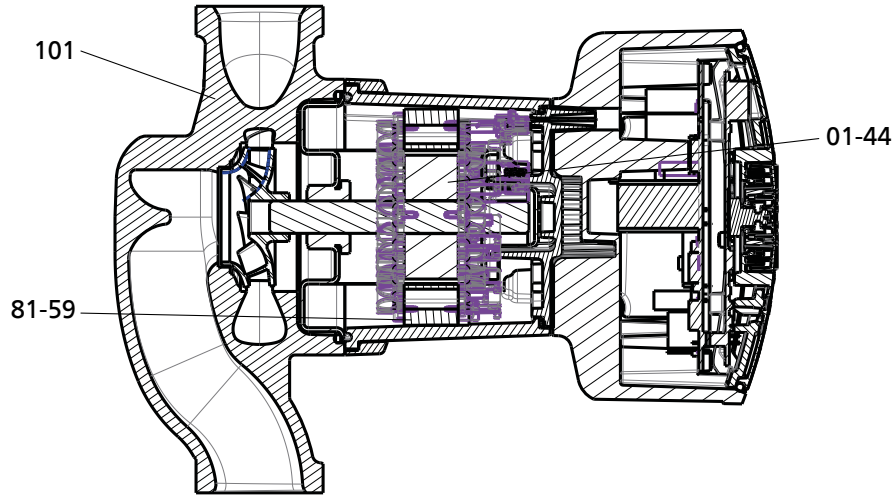

Part No.	Description	Part No.	Description
01-44	Rotor	101	Volute casing
81-59	Stator		

9.2 Wiring diagrams

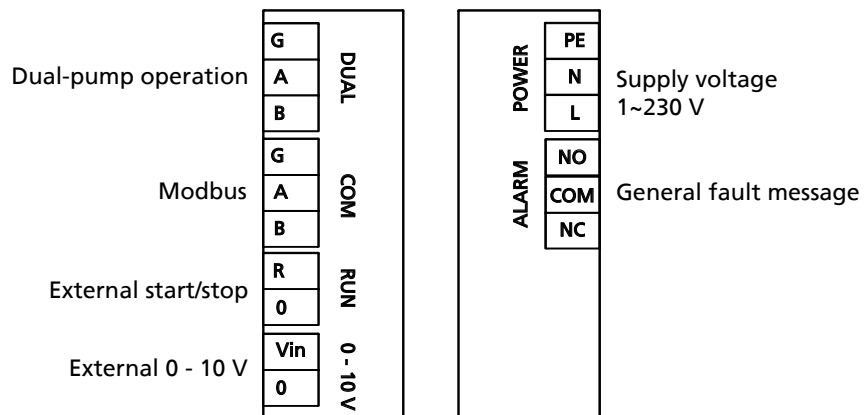

Fig. 35: Wiring diagram Magneta D Smedegaard 30-60/-100, 32-80/-120, 40-80/-100 and 50-80⁹⁾

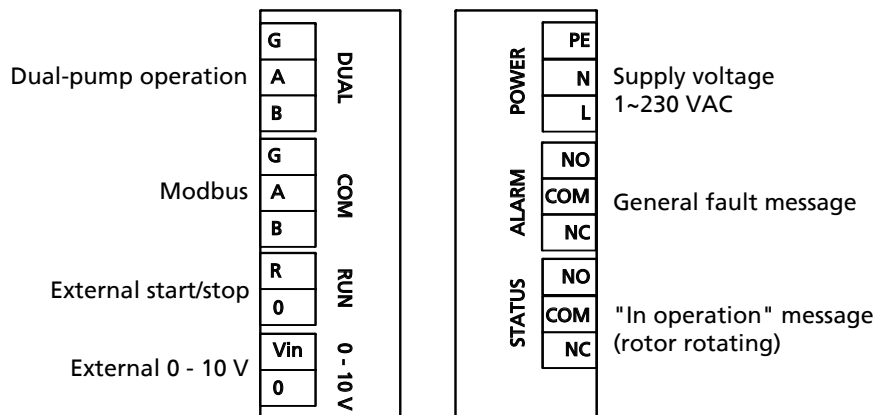
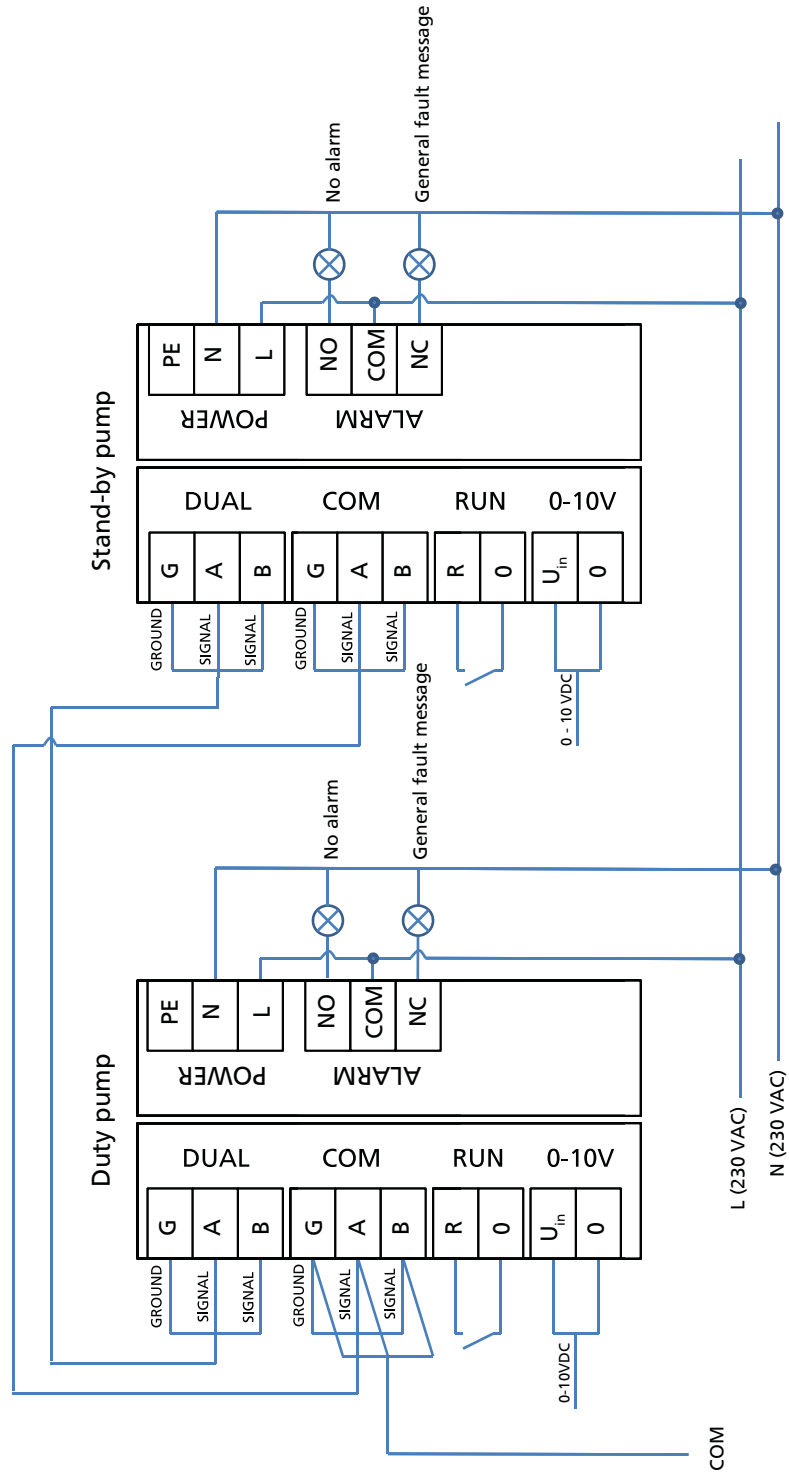

Fig. 36: Wiring diagram Magneta D Smedegaard 40-120/-180, 50-100/-120 and 65-80/-120

⁹⁾ Pump sizes 30-60/-100, 32-/80/-120, 40-80/-100 and 50-80 are supplied without Modbus function.

9.2.1 Wiring of dual pumps

Wiring of dual pumps, sizes 30-60/-100, 32-80/-120, 40-80/-100, 50-80¹⁰⁾



Wiring of dual pumps, sizes 40-120/-180, 50-100/-120, 65-80/-120, 80-120

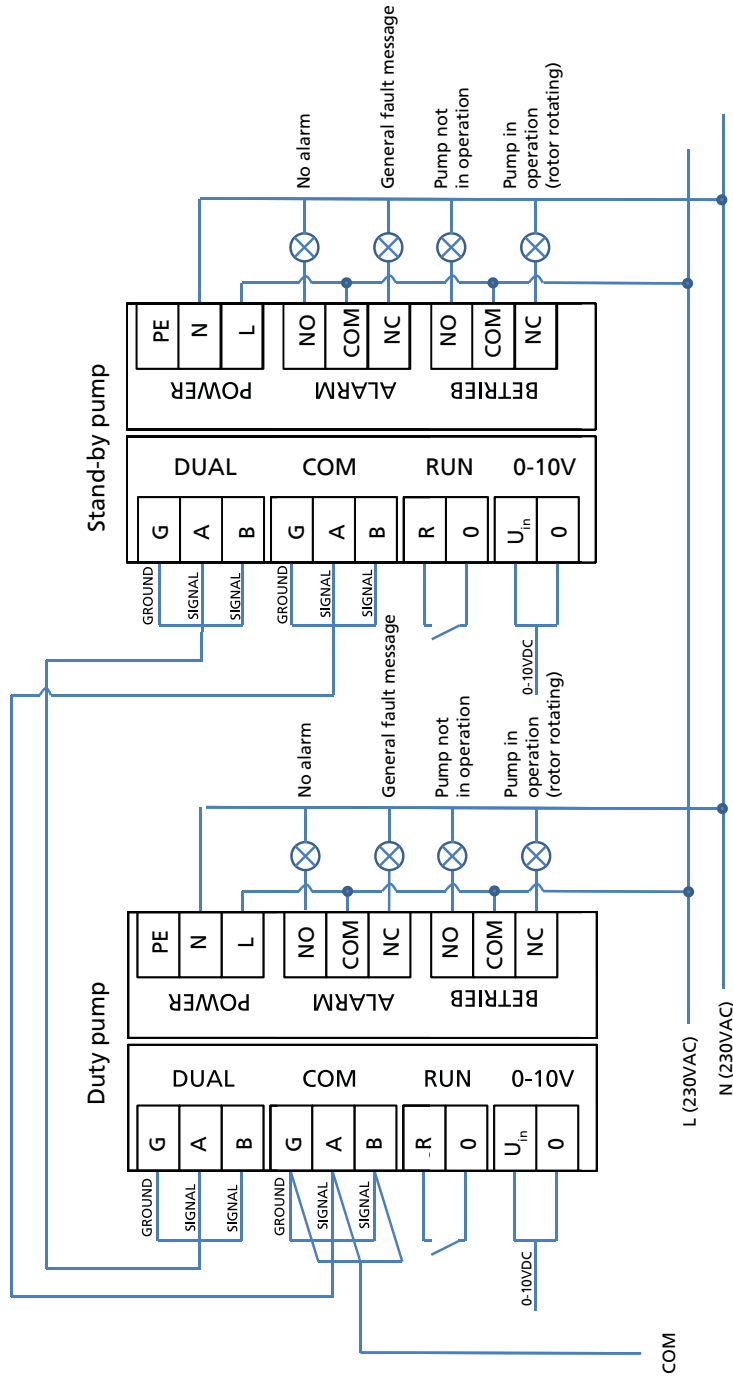

NOTE

Use the two DIP switches to enable bus termination of both DUAL terminals.



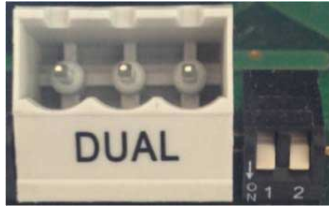

Fig. 37: DUAL terminals

¹⁰⁾ These pump sizes are supplied without Modbus function.

10 EC Declaration of Conformity

Manufacturer:

Duijvelaar Pompen
DP Pumps
Kalkovenweg 13
2401 LJ Alphen aan den Rijn (The Netherlands)

The manufacturer herewith declares that **the product**:

Magneta D Smedegaard

Series number: 1602-00001 - 1616-99999

- is in conformity with the provisions of the following Directives as amended from time to time:
 - Pump set: EC Machinery Directive 2006/42/EC
 - Pump set: Low-voltage Directive 2006/95/EC
 - Pump set: EC Electromagnetic Compatibility Directive 2004/108/EC
 - Pump set: Ecodesign Directive 2009/125/EC, Regulations No. 641/2009 and 622/2012

The manufacturer also declares that

- the following harmonised international standards have been applied:
 - EN 809
 - EN 60335-1, EN 60335-2-51
 - EN 61000-6-2, EN 61000-6-3
 - EN 16297-1, EN 16297-2

Person authorised to compile the technical file:

Wil Ouwehand
Technical Director
KSB B.V.
(subsidiary DP Industries B.V.)
Kalkovenweg 13
2401 LJ Alphen aan den Rijn (The Netherlands)

The EC Declaration of Conformity was issued in/on:

Alphen aan den Rijn, 1 December 2015



Wil Ouwehand
Technical Director
KSB B.V.
Kalkovenweg 13
2401 LJ Alphen aan den Rijn

Index

A

Applications	7
Automatic functions	14

B

Bearings	13
----------	----

C

Commissioning	27
Connections	13

D

Design	13
Designation	12
Disposal	11
Drive	13

F

Faults	
Causes and remedies	52
Fluid handled	
Density	49

I

Intended use	7
--------------	---

M

Manual functions	14
Misuse	8

N

Name plate	13
------------	----

O

Operating limits	48
Operating modes	14

P

Piping	20
Preservation	11, 49

60 / 64

R

Return to supplier	11
Returning to service	49

S

Safety	7
Safety awareness	8
Scope of supply	15
Shutdown	49
Signalling and display functions	14
Start-up	28
Storage	11, 49

T

Transport	10
-----------	----





duijvelaar pompen

duijvelaar pompen

Postbus 28

2400 AA Alphen aan den Rijn (The Netherlands)

Tel.: +31 172 48 83 88

Fax: +31 172 46 89 30

dp@dp.nl

www.dp.nl

Belgium

Tel.: +32 800 78 48 0

www.duijvelaar-pompen.be

21/01/2016

BE00000603 (1157.8460/03-EN)

